

# Intrinsically safe solenoid valves

on/off controls - ATEX certification

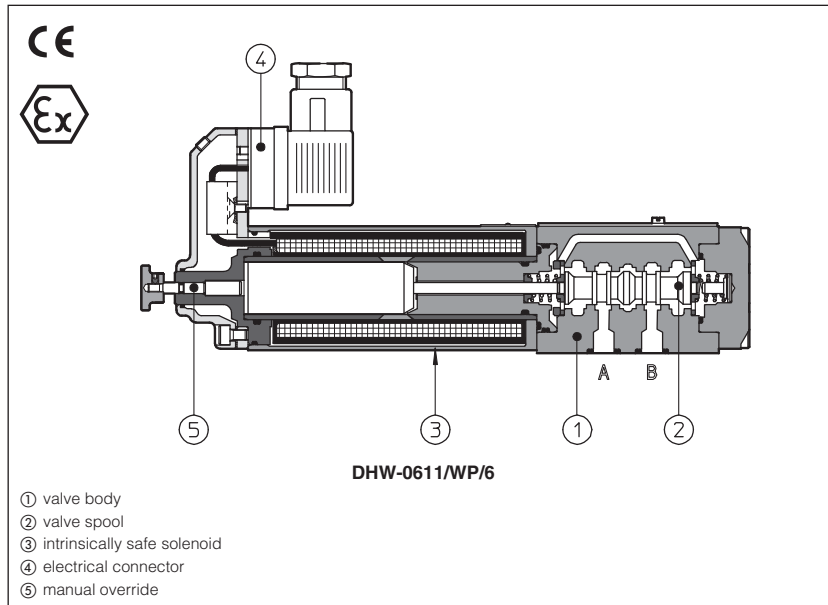

On/off valves equipped with intrinsically safe solenoids certified according to ATEX 94/9/CE, protection mode:

- Ex II 1 G, Ex ia IIC T6, IIB T6 or IIA T5 (surface plants with gas or vapours environment, category 1, zone 0, 1 and 2).
- Ex I M2 Ex ia I (solenoids group I for surface, tunnels or mining plants).

"Intrinsically safe" protection is based on the principle of limiting the energy of electric circuits in environments with presence of hazardous atmospheres. For this reason the valves must be supplied through specific "safety barriers" which limitate the max current to the solenoid. Atos provides galvanically insulated barriers for single and double solenoid valves, see section 18 to 21. The "intrinsically safe" circuit is virtually unable to produce electrical surges or thermic effects able to cause explosion in hazardous environments also in presence of specific break-down situations.

## 1 INTRINSICALLY SAFE SOLENOIDS: MAIN DATA

Solenoid code	Group II	<b>OW-18/6</b>	<b>OW-18/H</b>
	Group I (mining)	<b>OWM-18/6</b>	<b>OWM-18/H</b>
Nominal resistance at 20°C	150 Ω		
Coil insulation	Class H		
Protection degree	IP65		IP67
Duty factor	100%		
Electrical connector	DIN 43650 2 pin+GND		MIL-C-26482 3 pin

## 2 INTRINSICALLY SAFE SOLENOIDS: ELECTRICAL AND TEMPERATURE DATA

Method of protection	Ex ia / Ex ib according to EN60079-0: 2006, EN60079-11:2007								
Gas group	I and IIC			I and IIB	I and IIA	I			
Temperature class	T6			T6	T5	-			
Electrical characteristic	V max	27 V	19,5 V	19,11 V	28 V	28 V	12,2 V		
	I max	130 mA	360 mA	360 mA	250 mA	396 mA	2200 mA		
	P max	0,9 W	1,64 W	1,72 W	1,8 W	2,8 W	6,82 W		
Minimum supply current	≥ 65mA, for I.S. barriers see section 18 to 21								
Surface temperature (ambient temp. +60°C)	≤ 85°C				≤ 100°C		150 °C		
Ambient temperature	-40 ÷ +60°C (1)						-20 ÷ +60°C		

(1) The Group II solenoids are Atex certified for minimum temperature -40°C. Select /BT in the valve code for the application with minimum temperature -40°C

## 3 CERTIFICATIONS

In the following is resumed the valves marking according to the Atex Group I and Group II certification

### 3.1 GROUP II, Atex

- Ex** = Equipment for explosive atmospheres
- II** = Group II for surface plants
- I** = Very high protection (equipment category)
- G** = For gas and vapours
- ia** = Intrinsically safe execution
- IIC** = Gas group - application in surface plants
- T6 / T5** = Temperature class of the solenoid surface referred to +60°C ambient temperature
- Zone 0** (1 and 2) = Explosive atmosphere continuously present

### 3.2 GROUP I (mining), Atex

- Ex** = Equipment for explosive atmospheres
- I** = Group I for mines and surface plants
- M2** = High protection (equipment category)
- d** = Flame proof housing
- I** = Gas group (Methane)

### 3.3 EXAMPLE OF NAMEPLATE MARKING

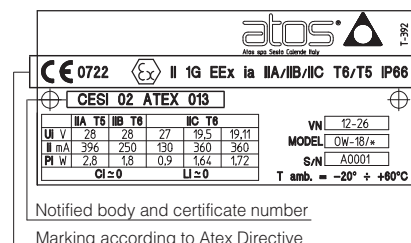

#### 4 MAIN CHARACTERISTICS OF INTRINSICALLY SAFE VALVES

Assembly position	the installation of DHW valves with the axis in vertical position is not recommended. If this type of installation is absolutely necessary, please consult our technical office
Subplate surface finishing	Roughness index $\sqrt{0.4}$ flatness ratio 0,01/100 (ISO 1101)
Ambient temperature	from -20°C to +60°C (standard, /WG and /PE seals) -40°C to +60°C for /BT option
Fluid	Hydraulic oil as per DIN 51524 .... 535; for other fluids see section 5
Recommended viscosity	15 ÷ 100 mm <sup>2</sup> /s at 40°C (ISO VG 15 ÷ 100) max viscosity 400 mm <sup>2</sup> /s
Fluid contamination class	ISO 18/15, achieved with in line filters at 10 µm value to $\beta_{10} \geq 75$ (recommended)
Fluid temperature	-20°C +60°C (standard, /WG and /PE seals) -40°C to +60°C for /BT option

#### 4.1 Corrosion protection characteristics

Valve screws: all screws made in stainless steel class A2

#### 5 MODEL CODE OF SPOOL TYPE ON-OFF DIRECTIONAL SOLENOID VALVES

<p><b>DH</b> = spool type - direct <b>DPH</b> = spool type - piloted</p> <p><b>W</b> = intrinsically safe solenoid, Atex certified</p> <p>omit for Group II <b>M</b> = Group I (mining)</p> <p>Valve size (ISO 4401): for DHW : <b>0</b> = size 06; for DPHW : <b>1</b> = size 10 <b>2</b> = size 16; <b>3</b> = size 25</p> <p>Valve configuration, DHW see section 6 and DPHW see section 7</p> <p>Spool type, DHW see section 6 and DPHW see section 7 3H = spool type 3H for marine applications (1) Only for DHW-071</p>	<p><b>0</b> <b>71</b> <b>3H</b> / <b>A</b> / <b>6</b> <b>**</b> <b>/*</b></p> <p>Synthetic fluids (2): <b>WG</b> = water-glycol <b>PE</b> = phosphate ester</p> <p>Series number</p> <p>Connector type - see section 17 <b>/6</b> = DIN 43650 (standard) <b>/H</b> = MIL-C-26482</p> <p>Options: <b>/A</b> = solenoid at side of port B <b>/WP</b> = prolonged manual override</p>
---	--

(1) Spool type 3H provides larger passages A-B to T in central position than spool type 3, see section 11.3

(2) Option **/BT** = low temperature -40°C also available on request (not for group I Atex -mining-)

#### 6 HYDRAULIC CONFIGURATIONS OF DHW VALVES

**Configuration for DHW**

Where the symbol doesn't show the hydraulic connection (\*), it depends by the central configuration of the spool

**Spools for DHW**

#### 7 CONFIGURATION OF DPHW VALVES

Where the symbol doesn't show the hydraulic connection (\*), it depends on the central configuration of the spool;

**Spools for DPHW valves**

**For all size**

**Only for DPHW-2, DPHW-3**

**8 MODEL CODE OF POPPET TYPE LEAK FREE ON-OFF DIRECTIONAL SOLENOID VALVES**

**DLOH** /<sup>\*</sup> - **2** **A** / **R** - **WO** / **6** **\*\*** /<sup>\*</sup>

directional control valve, poppet type size 06

omit for Group II  
**M** = Group I (mining)

**2** = 2 way  
**3** = 3 way

**A** = open in rest position  
**C** = closed in rest position

Options:  
/**R** = with check valve on port P  
/**WP** = prolonged manual override

Synthetic fluids (1):  
**WG** = water-glycol  
**PE** = phosphate ester

Series number

Connector type - see section 17  
/**6** = DIN 43650 (standard)  
/**H** = MIL-C-26482

**/WO** = intrinsically safe solenoid, Atex certified

(1) Option **/BT** = low temperature -40°C also available on request (not for group I Atex -mining)

**9 HYDRAULIC CONFIGURATIONS OF DLOH VALVES**

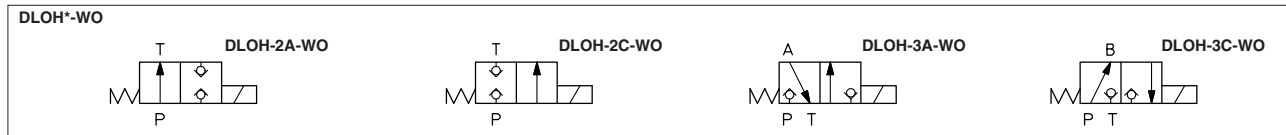

**10 Q/Δp DIAGRAMS based on mineral oil ISO VG 46 at 50°C**

**DHW**

spool type	0	0/2	1/2	1	3	3H
Flow direction						
P → A / P → B	4	5	5	3	3	3
A → T / B → T	6	2	1	2	4	5

**DLOH\*-WO**

configuration	2A	2C	3A	3C
Flow direction				
P → A / P → B (1)	1	2	4	3
A → T / B → T	-	-	5	4

(1) For two-way valves pressure drop refers to P → T

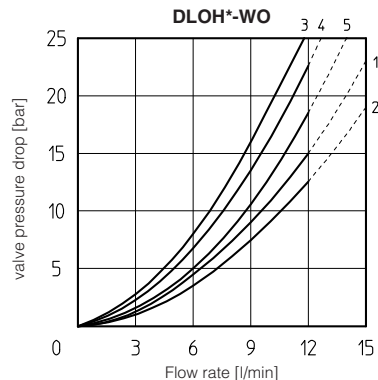
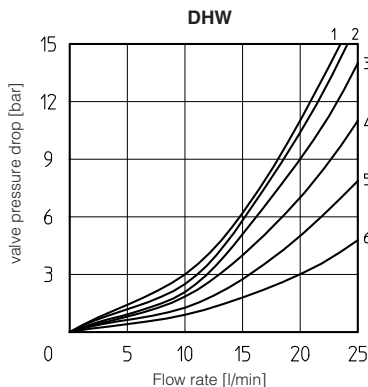

**11 OPERATING LIMITS based on mineral oil ISO VG 46 at 50°C**

The diagrams refer to warm solenoids and power supply provided by the Atos barrier type **Y-BXNE-412**. For DHW valves the curves refer to application with symmetrical flow through the valve (i.e. P → A and B → T). In case of asymmetric flow the operating limits must be reduced.

DHW type	0	0/2	1/2	1	3	3H
Diagram	B	B	C	C	A	D

DLOH type	2A	2C	3A	3C
Diagram	G	G	F	E

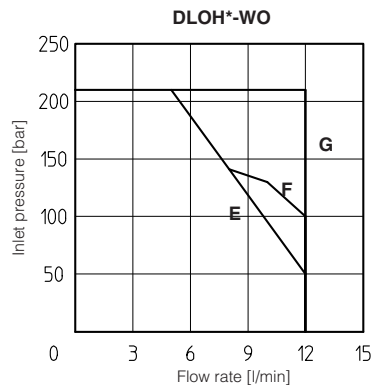
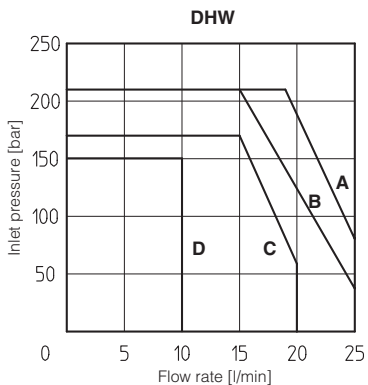

**11.1 Operating pressure:**

Ports P, A, B = 350 bar Port T = 160 bar

**11.2 Operating limits (only for DHW-0713H)**

Max flow = 10 l/1' - Max pressure = 150 bar

**11.3 Flow capability in central position A-B → T (only for DHW-0713H)**

Max flow = 25 l/1' with Δp 10,5 bar

**12 INTERNAL LEAKAGES**

**12.1 DHW internal leakages**

18 cm<sup>3</sup>/min with P=100 bar - fluid viscosity = 43 cSt at 40 °C  
30 cm<sup>3</sup>/min with P=140 bar - fluid viscosity = 22 cSt at 45 °C

**12.2 DLOH\*-WO internal leakages based on mineral oil ISO VG 46 at 50°C**

less than 5 drops/min (0,36 cm<sup>3</sup>/min) at max pressure.

**13 MODEL CODE OF PRESSURE CONTROLS**

**AGAM**

**/\*** - 20 / 2 0 / 210 - WO / WP / 6 \*\* **/\***

**AGAM** = pressure relief valve, subplate mounting, see tab. C066  
**ARAM** = pressure relief valve, threaded connections, see tab. C045

Omit for Group II  
**M** = Group I (mining)

Valve size for AGAM: for ARAM:  
**10** = size 10 (ISO 6264); **20** = G 3/4";  
**20** = size 20 (ISO 6264); **32** = G 1 1/4"  
**32** = size 32 (ISO 6264);

Number of the different setting pressure values:  
**1** = one setting pressure  
**2** = two setting pressure  
**3** = three setting pressure

Valve configuration  
**0** = venting with de-energized solenoid  
**1** = venting with energized solenoid  
**2** = without venting

Synthetic fluids (1):  
**WG** = water-glycol  
**PE** = phosphate ester

Series number

Connector type - see section 17

**/6** = DIN 43650 (standard)  
**/H** = MIL-C-26482

Option:

**/W/P** = prolonged manual override

**WO** = Intrinsically safe solenoid, Atex certified

Pressure range of first/second/third setting:  
**50** = 4 - 50 bar **210** = 7 - 210 bar  
**100** = 6 - 100 bar **350** = 8 - 350 bar

(1) Option **/BT** = low temperature -40°C also available on request (not for group I Atex -mining-)

**14 HYDRAULIC CHARACTERISTICS**

Valve model	AGAM-10-WO	AGAM-20-WO	AGAM-32-WO
Max pressure [bar]		350	
Setting		50; 100; 210; 350	
Pressure range [bar]		4÷50; 6÷100; 7÷210; 8÷350	
Max flow [l/min]	200	400	600

**15 MODEL CODE OF COVERS FOR CARTRIDGE VALVES**

**LIDEW**

**/\*** 1 - 1 / \* - WO / 6 \*\* **/\***

Cover type:  
**LIDBH** = with solenoid valve and shuttle valve for pilot selection  
**LIDEW** = with solenoid valve for pilot selection

Omit for Group II  
**M** = Group I (mining)

Valve configuration, see section 16

Valve size (ISO 7368)  
 for LIDBH\*: **1** = 16, **2** = 16, **3** = 16, **4** = 16, **5** = 50  
 for LIDEW\* **1** = 16, **2** = 16, **3** = 16, **4** = 16, **5** = 50, **6** = 63, **8** = 80

Options:  
**/B** = cartridge piloted via port "B" of solenoid pilot valve  
**/E** = external attachments X (G 1/4") and underneath port X supplied plugged (only for sizes 40 to 80)

Synthetic fluids (1):  
**WG** = water-glycol  
**PE** = phosphate ester

Series number

Connector type - see section 17  
**/6** = DIN 43650 (standard)  
**/H** = MIL-C-26482

**WO** = Intrinsically safe solenoid, Atex certified

Note: for the code of the ISO cartridge to use with the above covers see tab. H003, section 2 and tab. H030, section 3.

(1) Option **/BT** = low temperature -40°C also available on request (not for group I Atex -mining-)

**16 HYDRAULIC SYMBOLS**

**17 SOLENOID DIMENSIONS AND WIRING**

**Dimension [mm]**

**OW-18/6 (standard)**

**Option /H**

**Option /WP**

Connector wiring		
/6	/H	Connections
1	A	Coil
2	C	Coil
3	B	GND

**DIN 43650**

**MIL-C-26482**

cover shape for mining version

note: the connectors are supplied with the valves

**18 INTRINSICALLY SAFE BARRIERS**

The electric supply to these solenoids must be done through electronic devices situated out of potentially flammable environment (i.e. in safe zone), which limit the electric current to the intrinsically safe solenoid. These electronic devices are normally called "intrinsically safe barriers" approved and certified according to the Ex ia protection mode. To select the proper intrinsically safe barriers following data must be considered:

- 1)  $V_{max}$  and  $I_{max}$  of the solenoid as specified in section 2 must not be exceeded also in fault conditions;
- 2) the resistance of the solenoid is  $150 \Omega$  and the current supplied by the barrier, in normal operation condition, must be over the min. limit (65 mA) to ensure the valve correct operation (over 70 mA for max performances).

The barriers type Y-BXNE 412 are galvanically isolated electronic devices, developed according to the European Norms EN60079-0/06, EN60079-11/07 and certified ATEX 94/9/CE, protection mode Ex ia IIC.

These barriers ensure the optimized functioning of the Atos valves up to the max operating limits specified in section 11.

The barriers Y-BXNE-412 are double channel type, suitable to operate valves with double or single solenoid.

Two single solenoid valves can be connected to the barrier (one to each channel) but they cannot be contemporary operated.

**19 MODEL CODE OF I.S. BARRIER**

**19.1 I.S. barrier for double solenoid valves  
Y-BXNE 412 00 \***

Supply voltage  
**E** = 110/230 VAC  
**2** = 24÷48 VDC

The above barrier can be used both for double or for single solenoid valves.

With one barrier, two single solenoid valves can be operated but not contemporary, see section 18.

**20 TECHNICAL CHARACTERISTICS OF I.S. BARRIER**

	<b>Y-BXNE 412</b>
N° output channels	2
Power supply voltage	110÷230 VAC ±10% (50/60 HZ) 21,6 ÷ 53 Vdc
Power consumption	< 3W
Output voltage $U_o$	19,5 V
Output current $I_o$	341 mA
Output power $P_o$	1,64 W
Galvanic insulation supply/output	2500 VAC / 50 Hz
Storage temperature	-25 °C ÷ +70 °C
Working temperature	-10 °C ÷ +60 °C
Housing material	ABS case
Mounting	on rail EN 50022
Electrical connections	screw terminals
Method of protection	Ex ia IIC
ATEX classification	Ex II 1 G/D

21 INSTALLATION DIMENSIONS OF I.S. BARRIER [mm]

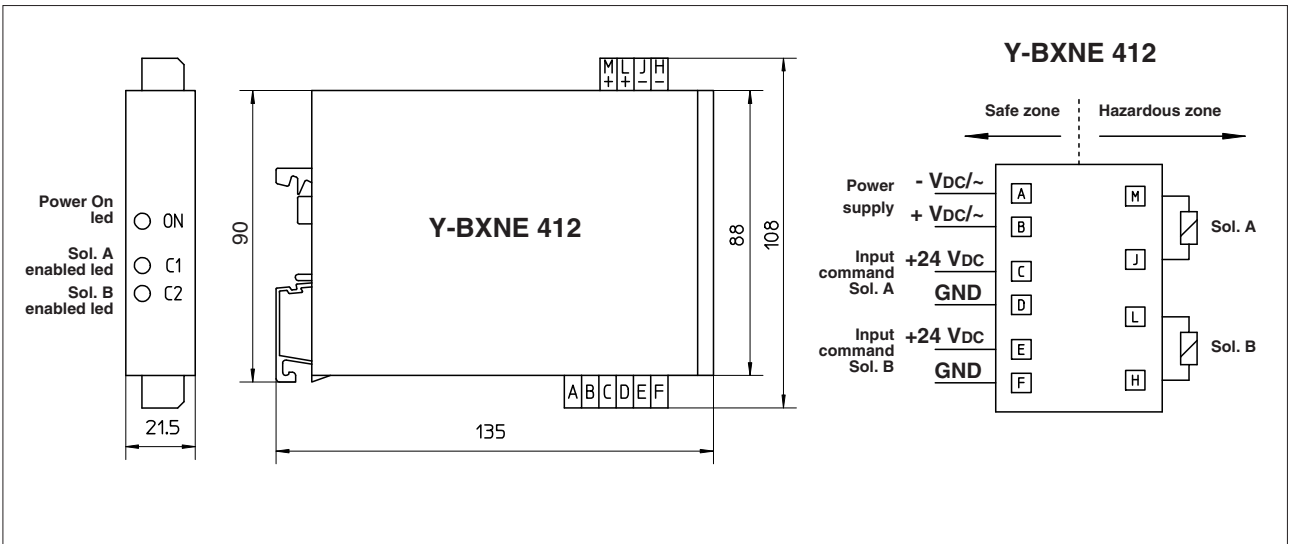

22 EXTERNAL PROFILE OF INTRINSICALLY SAFE VALVES [mm]

